



A Reputable & Leading of Pile Driving Equipment



BRUCE VIBRO HAMMER APPLICATION

01

- Fast driving and extracting casing piles by Vibratory Hammer
- Fixed construction combination with Sheet & Casing piles

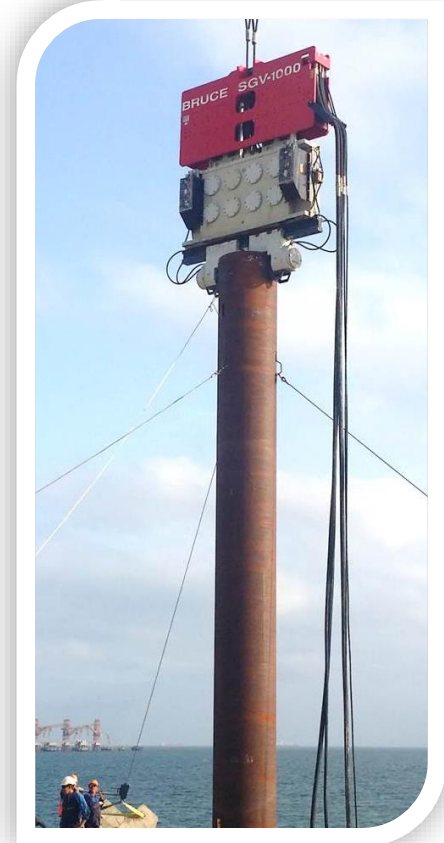

BRUCE
VIBRO HAMMER
APPLICATION

A simple black bar chart icon with three vertical bars of increasing height from left to right.

02

- Fast driving and extracting for sheet pile & casing pile by Vibratory Hammer
- Fixed construction combination with Sheet & Casing piles



BRUCE
VIBRO HAMMER
APPLICATION

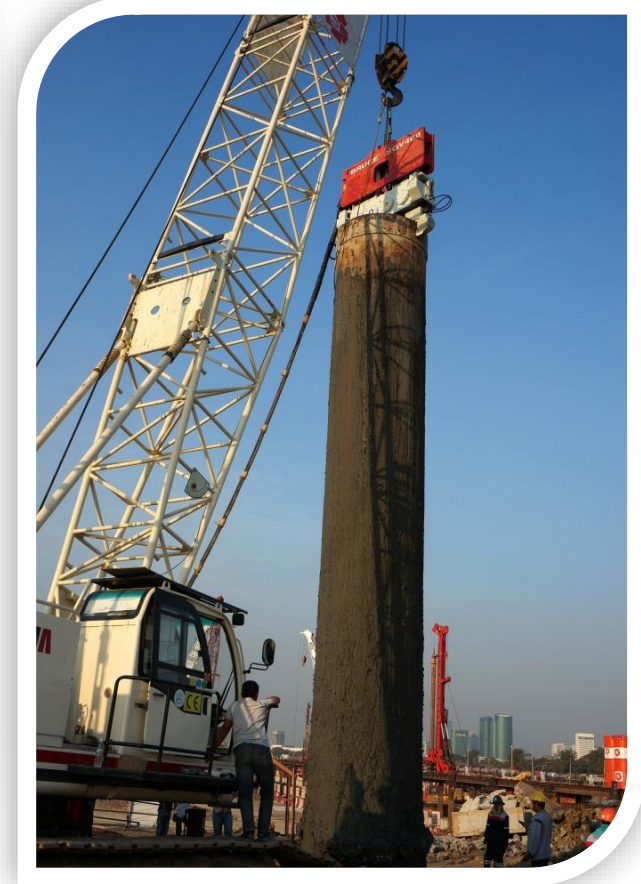
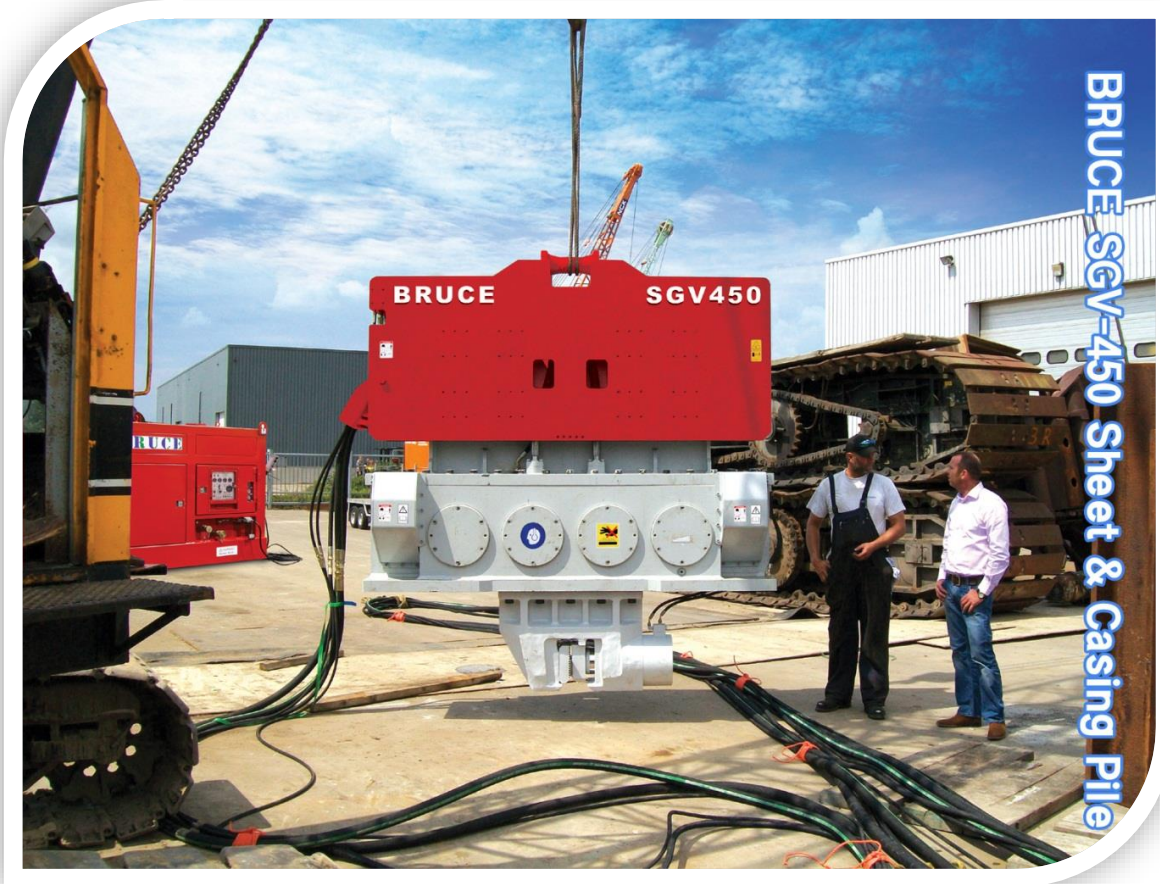

03

- Fast driving and extracting for sheet pile & casing pile by Vibratory Hammer
- Fixed construction combination with Sheet & Casing piles



BRUCE
VIBRO HAMMER
APPLICATION



05

- Fast driving and extracting for temporary construction
- Fixed construction combination with Sheet & Casing piles



BRUCE
VIBRO HAMMER
APPLICATION

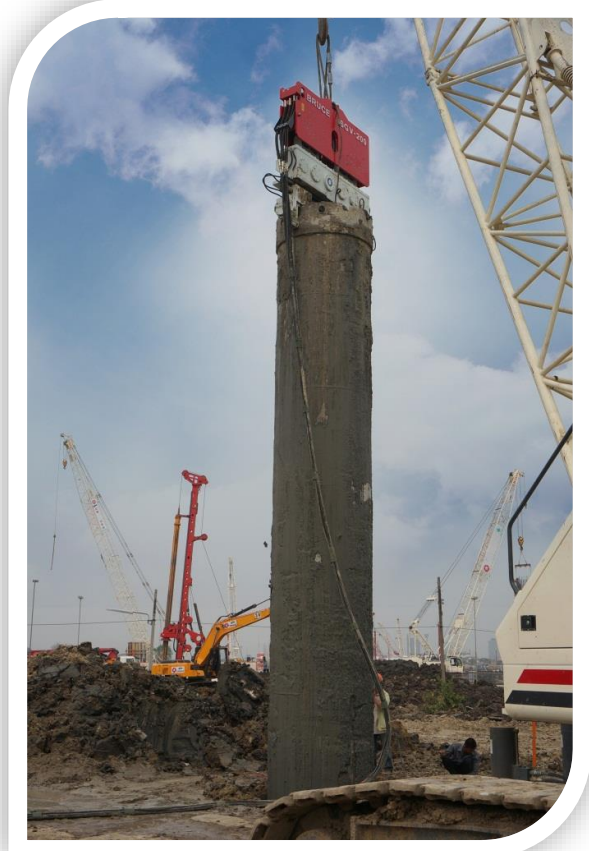
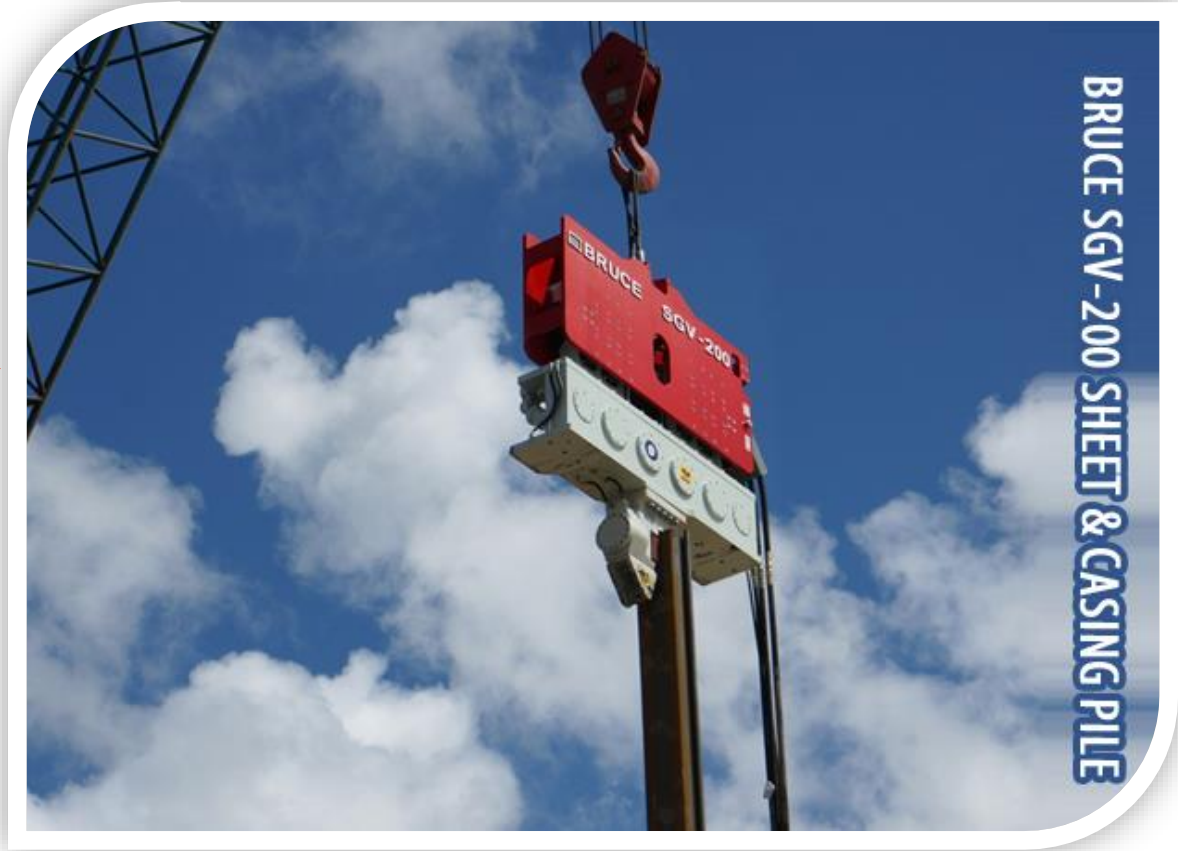

02

Typical design of operating composition of Vibro Hammer operation (casing pile driving)



Operating Structure of BRUCE Vibro Hammer (Casing Pile)

OPERATING CONNECTIONS

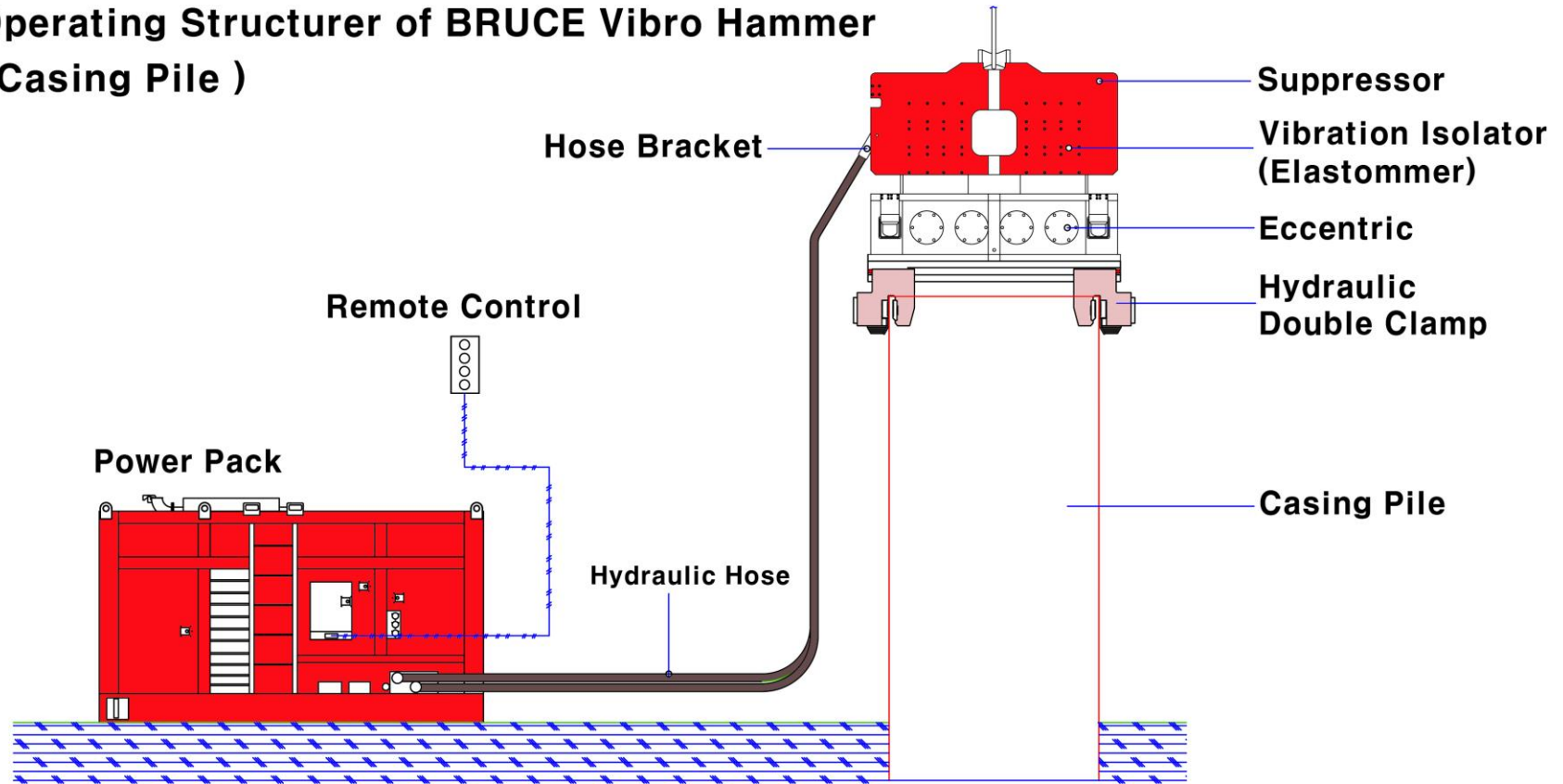

02

Typical design of operating composition of Vibro Hammer operation (sheet pile driving)



Operating Structure of BRUCE Vibro Hammer

OPERATING CONNECTIONS

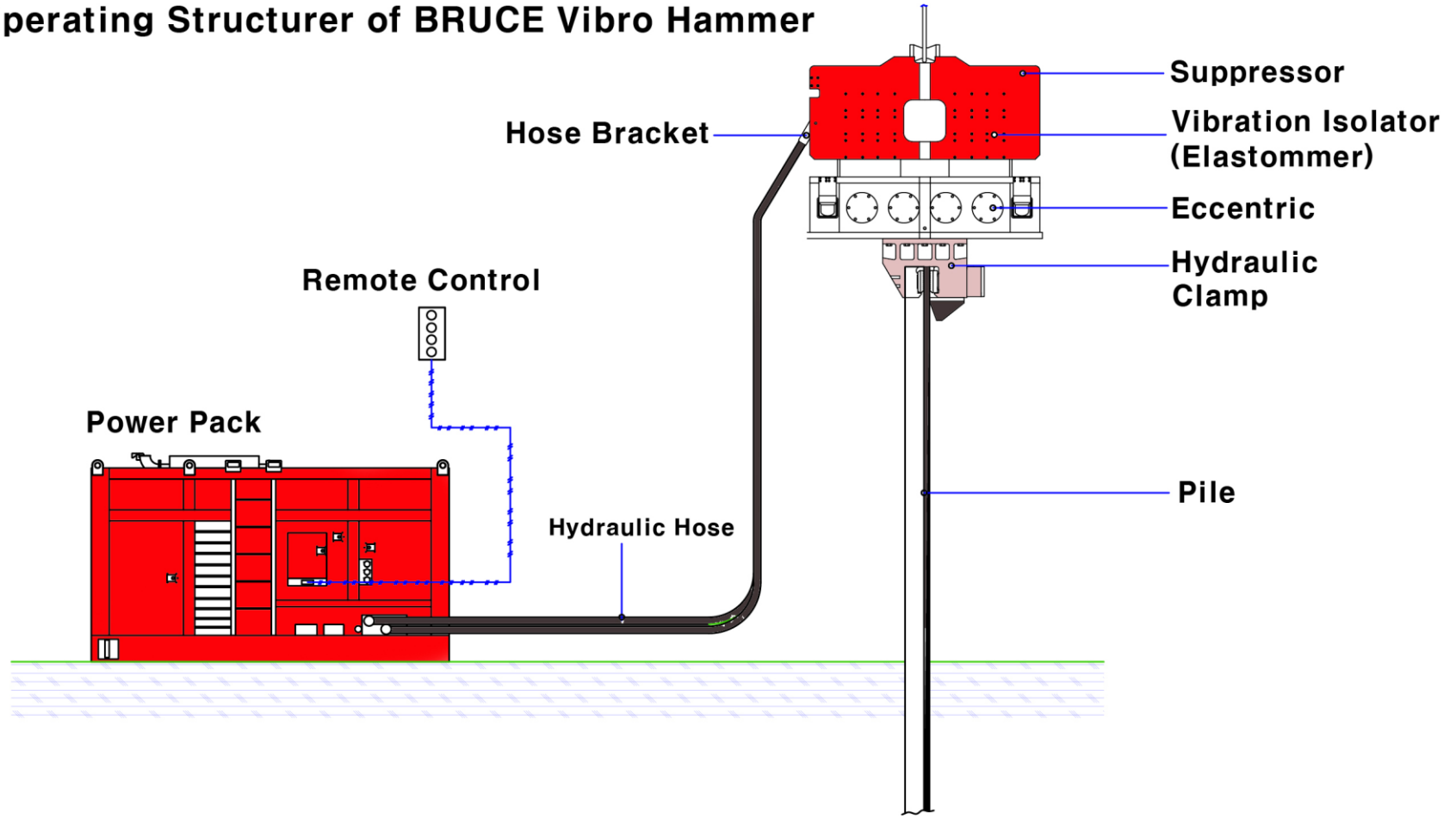

02

The principle of vibration start-up through centrifugal force adjustment with swiveling of the eccentrics.



HOW DOES VIBRO WORKS

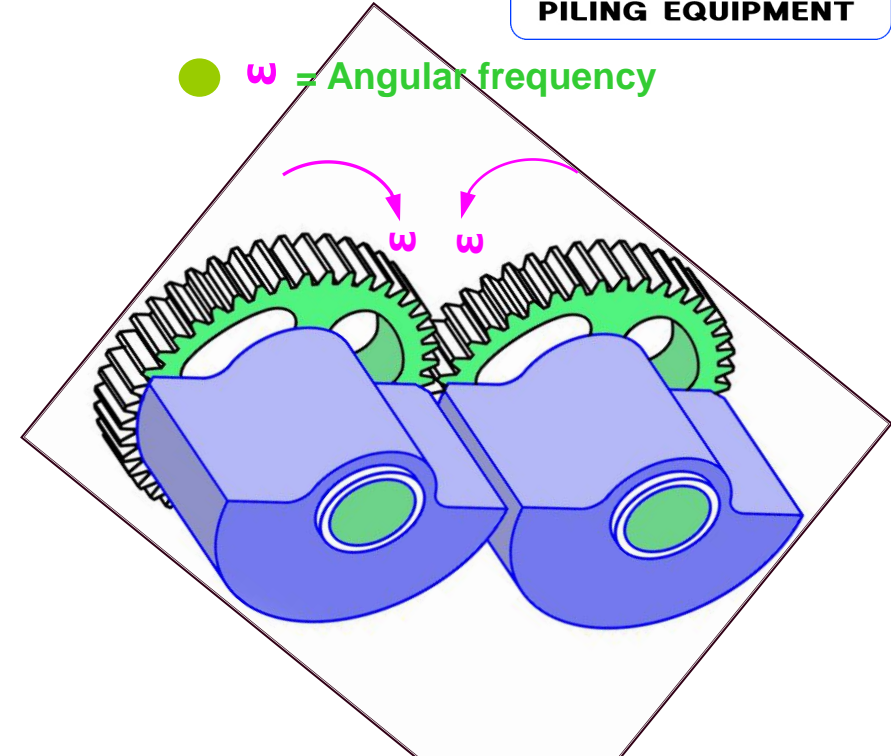
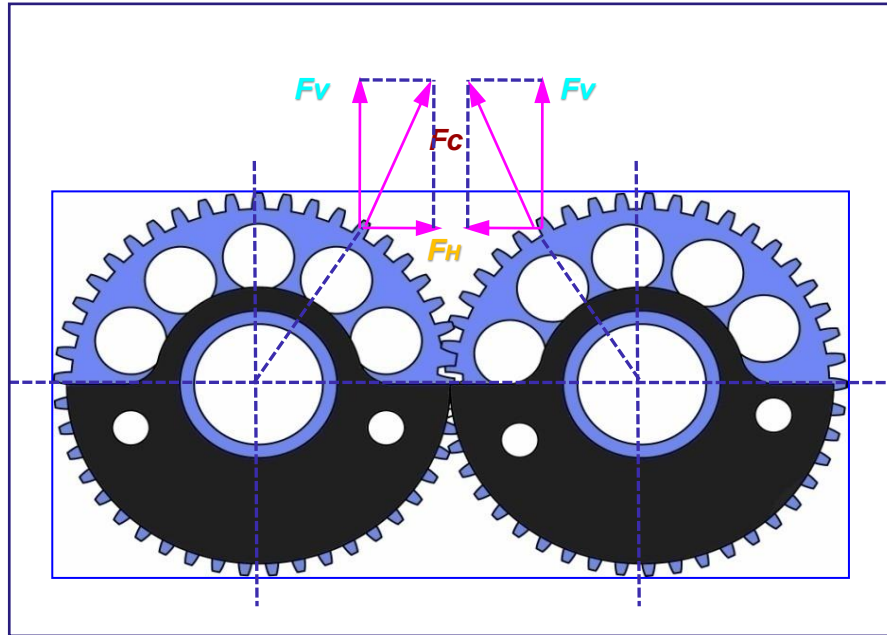

- F_c = Centrifugal Force
- F_v = Vertical Force
- F_H = Horizontal Force

Formula of Centrifugal Force
1) Angular frequency (rad/sec) : $2 \times 3.14 \times \text{Vibro vpm} / 60$
2) Centrifugal force (kN) : Eccentric Moment \times Angular frequency 2

03

It vibrates the sheet or Casing piles to be driven or extracted.



HOW DOES VIBRO WORKS

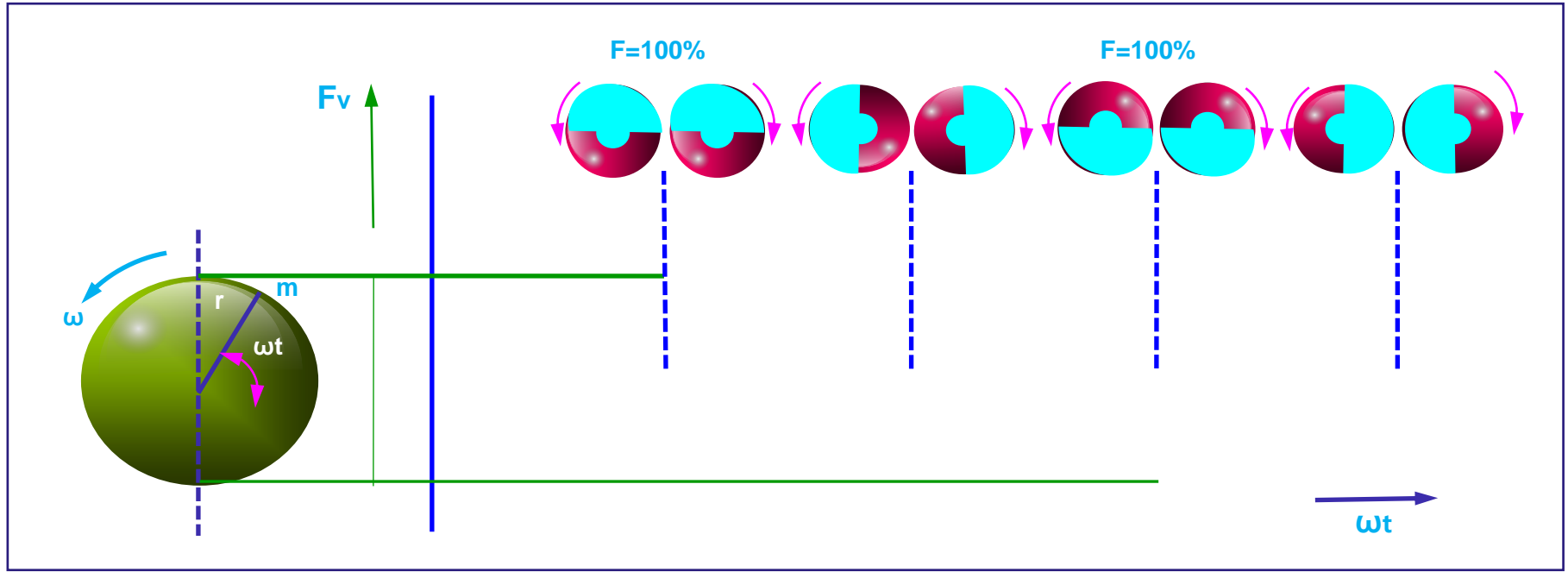

- F_v = Vertical Force
- ω = Angular frequency
- ωt = Angular frequency in m rad./s
- r = Rotations per minute
- m = Horizontal Force

04

Selecting the optimum Vibratory Hammer with selection chart



VIBRO HAMMER WORKS SELECTION

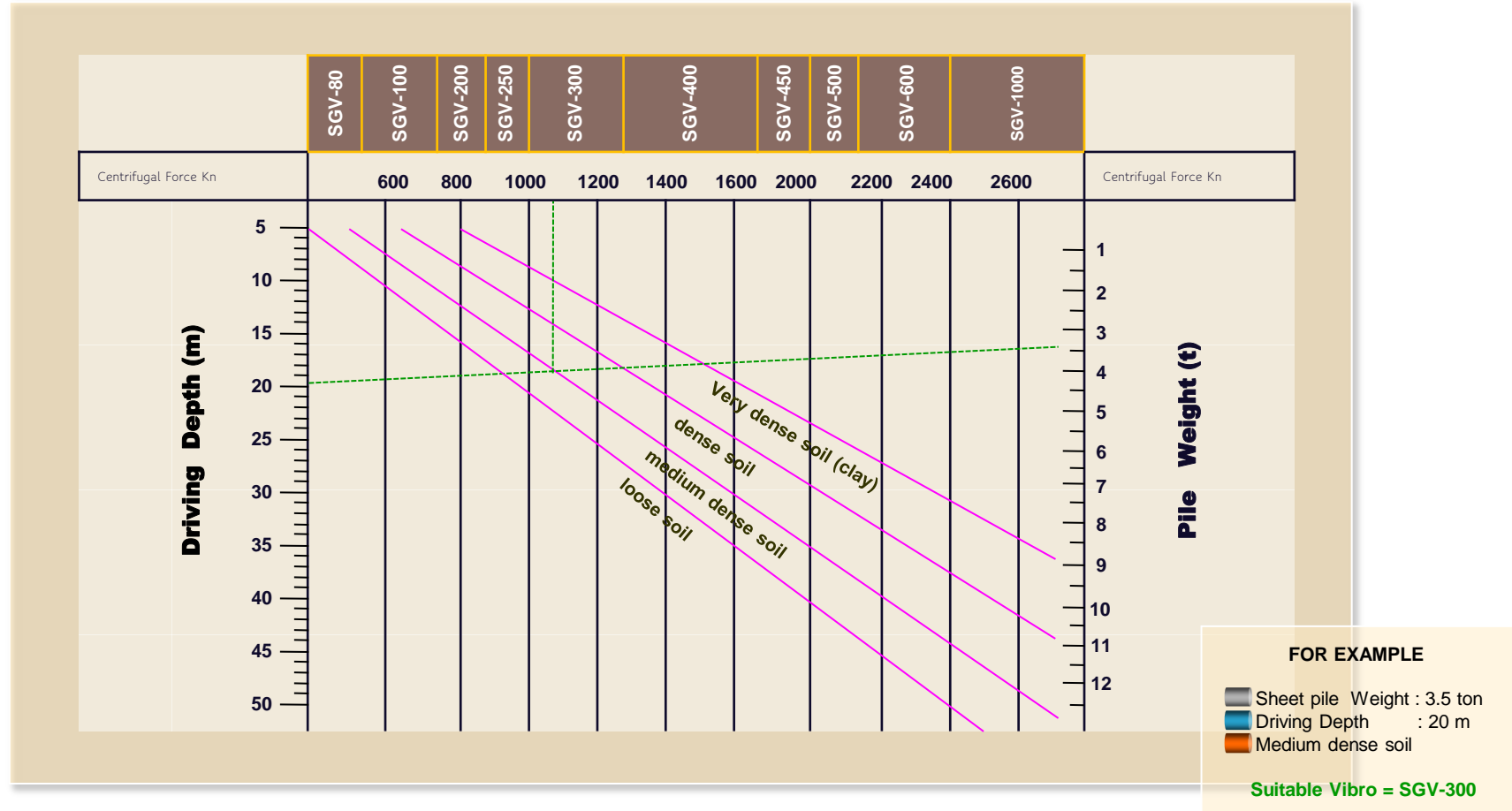

BRUCE PILING EQUIPMENT

Address : 15091, Sihwa Industrial Complex,
1265-12, Jeongwang-Dong, 44, Gunjacheon-Ro 131 Beon-Gil
Siheung-City, Gyeonggi-Do, Korea

Tel: +82-31-488-8026
Fax: +82-31-431-7490

E-mail: inquiry@powerquip.co.kr



www.powerquip.co.kr